

TOSHIBA

PLAIN PAPER COPIER

1340/1350
OPERATOR'S MANUAL

/1360/1370

TOSHIBA CORPORATION

2-1 SHIBAURA 1-CHOME, MINATO-KU, TOKYO, 105, JAPAN

© Copyright TOSHIBA CORPORATION 1993
ALL RIGHTS RESERVED

IN-D-173, 93-06AB

 4402840620

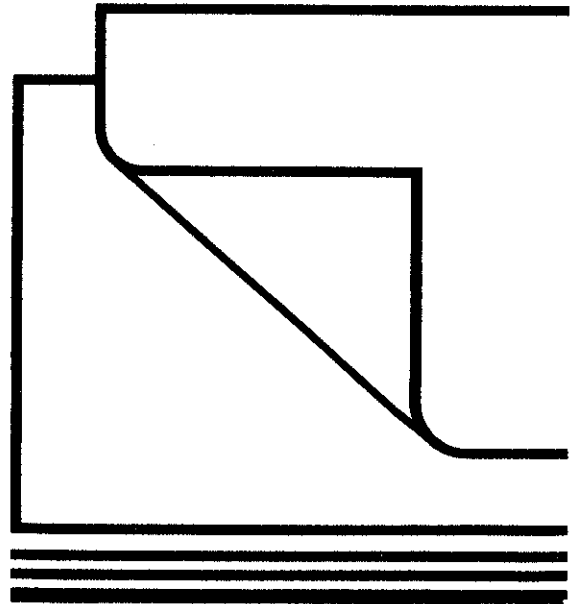

PREFACE

We are very happy you have chosen the Toshiba 1340/1350. The 1340/1350 is easy to maintain, designed for simple operation and makes excellent plain paper copies. This Operator's Manual gives a description of how to use this copier as well as how to remedy simple problems. We recommend that you read this manual thoroughly to ensure correct operation and keep it handy for future reference.

Features of the 1340/1350:

Equipped with an automatic exposure sensor (magic eye), this plain paper copier allows anyone to make clear copies easily. Its other features are as follows:

1. Copying speed of 13 copies per minute.
2. * Zooming function as well as fixed enlargement and reduction ratios.
3. A variety of copy sizes from maximum Folio to minimum A5.
4. Photographs will be copied clearly in the PHOTO mode.

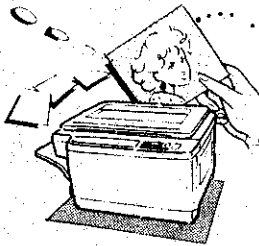





* 1350 only

The socket should be located near the machine and be easily accessible.

© COPYRIGHT 1993
TOSHIBA CORPORATION

CONTENTS

■ PRECAUTIONS	2
1. PRECAUTIONS FOR INSTALLATION	2
2. PRECAUTIONS FOR USING THE COPIER	3
■ DESCRIPTION OF THE COPIER	4
1. NAMES OF THE MAIN COMPONENTS	4
2. DESCRIPTION OF THE CONTROL PANEL	6
3. DESCRIPTION OF THE GRAPHIC DISPLAY	8
■ HOW TO MAKE COPIES	9
1. ACTUAL-SIZE COPYING	9
2. *ENLARGEMENT AND REDUCTION COPYING	11
3. BYPASS COPYING	13
4. COPYING IN THE PHOTO MODE	15
5. SELECTING THE EXPOSURE MODE	16
6. INTERRUPT COPYING	18
7. AUTO JOB START COPYING	19
8. POWER SAVING MODE (Option)	20
9. USING THE QUICK COPYING FUNCTION (Option)	21
	*1350 only
■ WHEN THE GRAPHIC SYMBOLS FLASH	22
1. ADD PAPER  SYMBOL	22
2. REPLACE TONER CARTRIDGE  SYMBOL	24
3. REPLACE TONER BAG  SYMBOL	27
4. CLEAR PAPER  SYMBOL	29
5. CALL SERVICE  SYMBOL	31
6. WHEN THE PRINT KEY LAMP DOES NOT BECOME GREEN	31
■ MAINTENANCE	32
1. CLEANING THE CHARGERS	32
2. CLEANING THE COPIER	33
3. SIMPLE TROUBLESHOOTING	34
■ SPECIFICATIONS AND OTHER ITEMS	38
1. SPECIFICATIONS	38
2. ACCESSORIES	39
3. OPTIONS	39
4. SUPPLIES	39

PRECAUTIONS

1. PRECAUTIONS FOR INSTALLATION

1 The 1340/1350 should be installed by a qualified service technician.

Note: The packing material should be disposed of properly.

2 To obtain the best possible results, this machine must be used in conjunction with a dedicated AC power line at one of the following ratings:

220 – 240V – 50/60Hz, 6A

Notes:

1. The use of other appliances or other equipment on the same line as this machine may adversely affect performance and copy quality.
2. Be sure to use a 3-conductor, grounded wall outlet.
3. In areas where a 2-pin plug is used, the machine must be grounded for safety.
Never ground it to a gas pipe, a water pipe, or any other object not suitable for grounding.

3 Select a suitable place for installation. Avoid excessive heat, dust, vibration and direct sunlight. Also, provide proper ventilation as the copier emits a slight amount of ozone.

4 To insure optimal operation, allow clearances of at least 80 cm (32") on the left, 50 cm (20") on the right and 25 cm (10") in the rear.

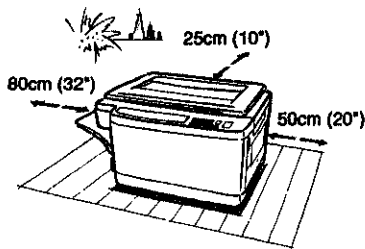

2

2. PRECAUTIONS FOR USING THE COPIER

1 Handle and use the machine gently and carefully.

- Do not place anything on the copy receiving tray, exposure glass or on top of the machine.
- Do not allow any metal things such as paper clips to drop into the machine.
- Never allow the power cable to be trampled on or pinched between hard objects, otherwise an accident or electrical trouble might occur.

2 Be sure to turn OFF the power switch:

- When you leave your office at night.
- If a power failure occurs.

Caution: When turning OFF the power switch, be sure to do so after the machine cycling has come to a complete stop.

Be sure to turn OFF the power switch immediately and call for service:

- If an unusual noise is heard from the machine.
- If the outside of the machine becomes unusually hot.
- Be sure to disconnect the power-cord plug when you do not intend to use the machine for an extended period of time such as during weekends or the summer holidays.

3 It is recommended that only supplies made or designated by Toshiba be used for the 1340/1350 in order to optimize copy quality. All supplies should be stored in a cool, dry area.

For optimum performance, it is recommended that 80 g/m² xerographic bond paper of high quality be used and properly loaded. Paper of lower quality may contain inherent properties such as excess paper dust and may lead to premature servicing.

Machine Noise Information Ordinance 3. GSGV, January 18, 1991: The maximum sound pressure level is equal or less than 70 dB (A) according to ISO 7779.

3

DESCRIPTION OF THE COPIER

1. NAMES OF THE MAIN COMPONENTS

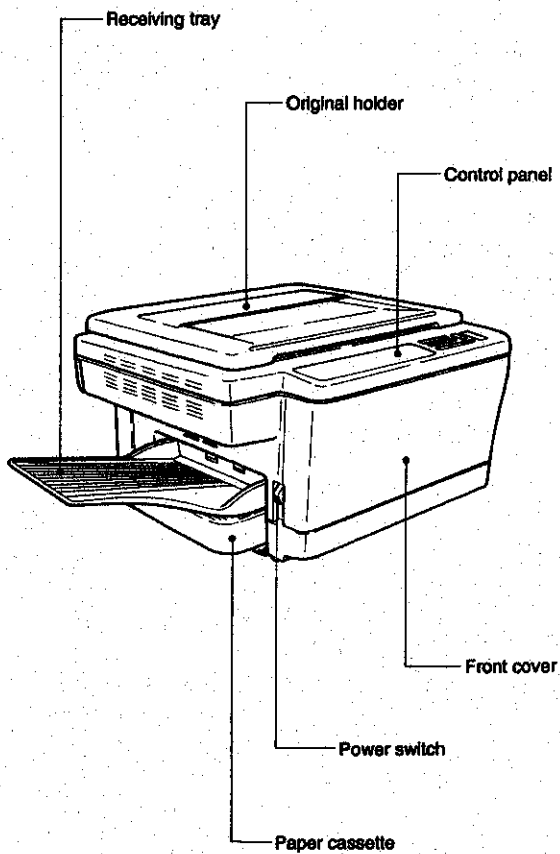

4

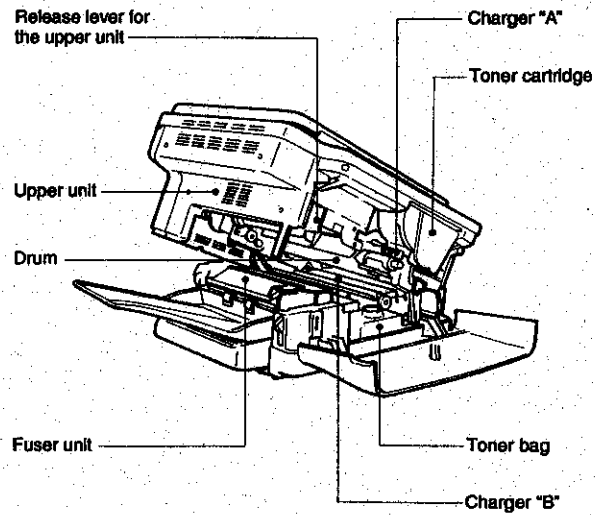
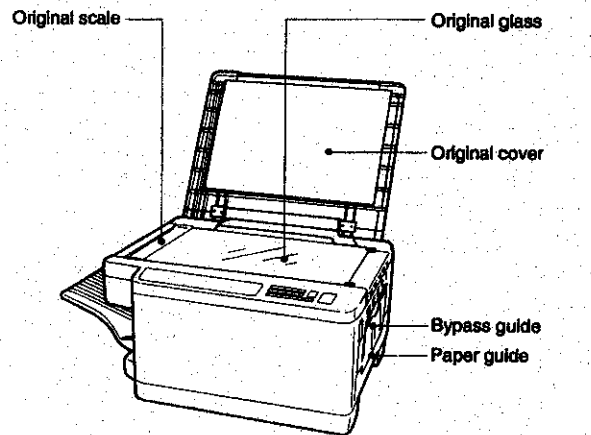

5

2. DESCRIPTION OF THE CONTROL PANEL

*This illustration is for the 1340.

Graphic Display:

Various graphic symbols flash indicating the status of the copier. For details, refer to page 8.

COPY QUANTITY/REPRODUCTION RATIO Display:

The number of copies keyed in is shown here. When you press the [%] key, the reproduction ratio is shown.

CLEAR/STOP [C/O] Key:

Use this key to correct the copy quantity entered or when you want to stop a multicopy run. During multicopying, pressing this key once will stop the copy run and pressing it twice will clear the copy quantity to "1".

MANUAL EXPOSURE Slide:

Use this slide to change the exposure level manually.

TOTAL COUNTER Display:

The total number of copies made after the copier was installed is shown here.

PRINT [P] Key:

Pressing this key will start the copying operation.

Digital Keys:

Use these keys to select the desired number of copies.

PHOTO [P] Symbol:

If you want to select PHOTO mode [P] copying, press the FUNCTION key and the symbol will be turned on.

FUNCTION Key:

Use this key to change the AUTOMATIC EXPOSURE mode or to use the PHOTO mode [P].

AUTOMATIC EXPOSURE [A] Symbol:

Normally, the automatic exposure mode is already selected and its symbol [A] is on. If you want to select the desired copy density or PHOTO mode [P] copying, press the FUNCTION key to extinguish its symbol.

6

*This illustration is for the 1350.

[%] Symbol:

If you press the [%] key or SELECTION key, the [%] symbol will be turned on.

[%] key:

Pressing this key will make the reproduction ratio appear and the [%] symbol will come on for 2 seconds. The number of copies keyed in will then be indicated.

ZOOM Keys:

You can select any reproduction ratio from 65% up to 141% in increments of 1%.

SELECTION Key:

Use This key to change the reproduction ratio (four standard settings). The [%] symbol lights and the reduction or enlargement ratio is displayed when you press this key.

7

3. DESCRIPTION OF THE GRAPHIC DISPLAY

Note: When any of the symbols flashes, take the appropriate action referring to the pages shown.



CALL SERVICE

Symbol:
Flashes when something abnormal has occurred in the copier and a visit by a service technician is necessary. See page 31.

CLEAR PAPER

Symbol:
Flashes when a paper misfeed occurs in the copier. See page 29.

ADD PAPER

Symbol:
Flashes when the paper supply in the cassette runs out or when the cassette is pulled out. See page 22.

REPLACE TONER

Symbol:
Flashes when the toner supply in the toner cartridge runs out. See page 24.

REPLACE TONER

Symbol:
Flashes when the toner bag becomes full of used toner. See page 27.

HOW TO MAKE COPIES

1. ACTUAL-SIZE COPYING (1)

- 1 **Turn on the power switch.**
 - The lamp on the PRINT key becomes red for about 30 seconds and then changes to green.
 - When this lamp changes to green, you can make copies at any time.
 - During copying the PRINT key lamp changes from green to red.

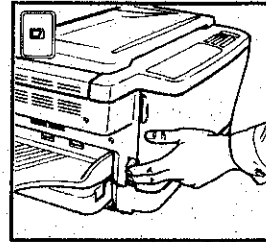

- 2 **Place the original.**
 - Lifting the original cover, place the original face down on the glass. Align it between the proper size marks of the original scale, and lower the original cover slowly.

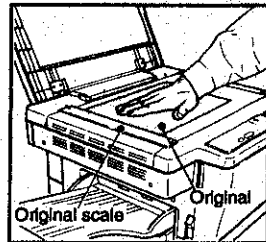

- 3 **Select the exposure.**
 - Normally, the automatic exposure mode is already selected and its symbol is on.

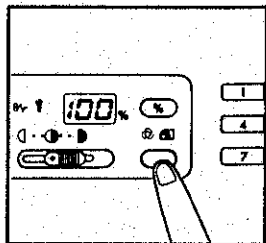

- If you want to select the desired copy density, press the FUNCTION key to extinguish its symbol and then adjust the manual exposure slide. Move it toward the left to lighten and toward the right to darken your copies.

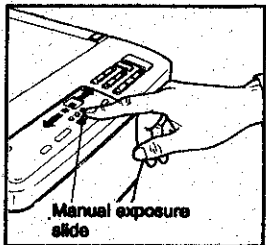

1. ACTUAL-SIZE COPYING (2)

4 Key in the desired number of copies.

- There is no need to do so when you make only one copy of each of your originals.
- Up to 199 copies can be set.

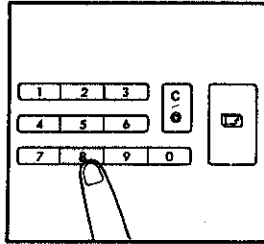

- When an incorrect quantity is set, first press the CLEAR/STOP C/O key, then key in the correct number.

- After having set the desired number of copies, if the PRINT P key is not pressed within about 45 seconds, the copier will automatically return to the automatic exposure mode and the copy quantity "1".

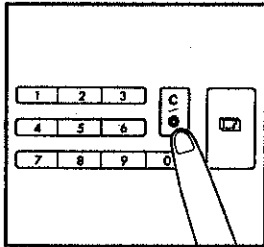

5 Press the PRINT P key.

- Copying is started and the copies will exit into the receiving tray.

Caution:
Do not open the paper guide during copying.

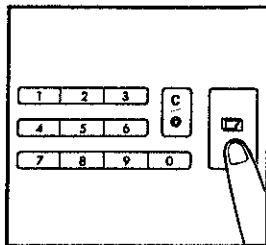

10

2. ENLARGEMENT AND REDUCTION COPYING (1)

Note: Copies cannot be made in this mode using the 1340.

1 Check the size of the paper cassette.

- If it is not the size you want, use the bypass copying mode. See page 13. Or you can change the cassette if you have another one. See page 22.

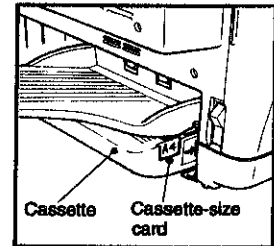

2 Select the desired reproduction ratio.

- Pressing the SELECTION key enables you to select the desired reproduction ratio.
- The selected reproduction ratio will light on the display.

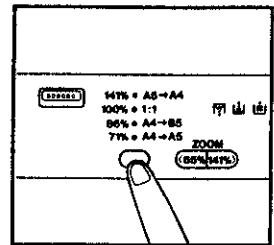

- If there is no fixed reproduction ratio matching your desired enlargement or reduction ratio, use the ZOOM keys. You can select any ratio from 65% up to 141% at increments of 1%.

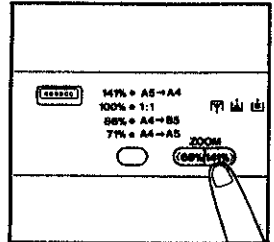

3 Place the original

- Lifting the original cover, place the original face down on the glass, and align it between the proper size marks of the original scale.
- Lower the original cover slowly.

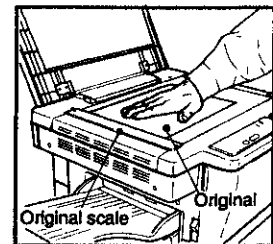

11

2. ENLARGEMENT AND REDUCTION COPYING (2)

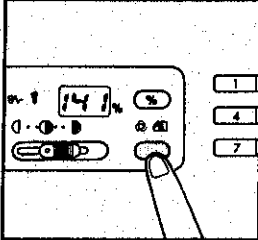
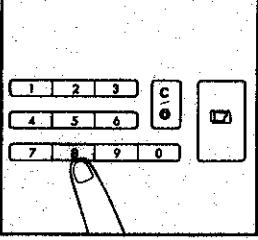
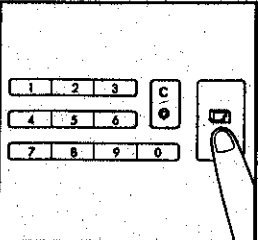
- 4 **Select the exposure.**
 - Normally, the automatic exposure mode is already selected and its symbol is on.
- 5 **Key in the desired number of copies.**
 - There is no need to do so when you make only one copy of each of your originals.
- 6 **Press the PRINT key.**
 - Enlarged or reduced copies will exit into the receiving tray.

12

3. BYPASS COPYING (1)

Use the bypass copying mode when the size of the paper cassette installed in the copier is not the size you require or when you want to use a special size or type of paper.

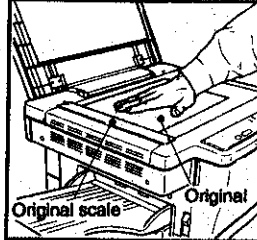
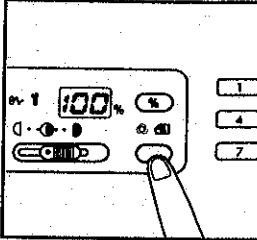
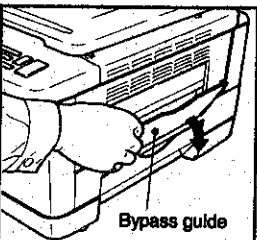
- 1 **Place the original.**
 - Lifting the original cover, place the original face down on the glass. Align it between the proper size marks of the original scale, and lower the original cover slowly.
- 2 **Select the exposure.**
 - Normally, the automatic exposure mode is already selected and its symbol is on.
- 3 **Open the bypass guide.**

13

3. BYPASS COPYING (2)

4 Push in one sheet of paper gently along the bypass guide until it comes to a stop.

- The green lamp on the PRINT  key will start to flash.
- If the paper is curled, correct the curl and reinsert it.

Caution: Hold the paper straight until it begins to move after the PRINT  key has been pressed.

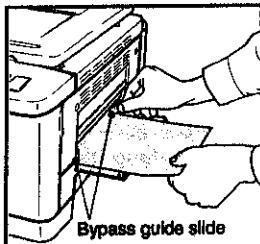

5 Holding the paper lightly, press the PRINT  key.

- Copying is started and the copies will exit into the receiving tray.
- When copying 2 or more sheets, wait until the lamp on the PRINT  key has become green before inserting the next sheet.

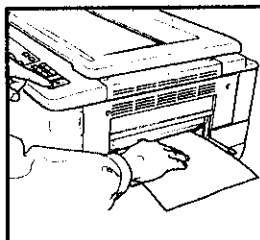

6 Close the bypass guide.

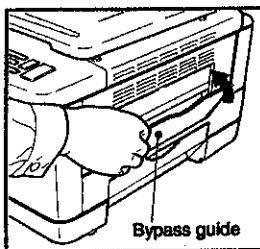

4. COPYING IN THE PHOTO MODE

When photographs, etc. are copied in the automatic or manual exposure mode, the copied images tend to become dark, losing image contrast. In the PHOTO mode, they will be copied clearly.

1 Place the original.

- Set it face down on the glass.

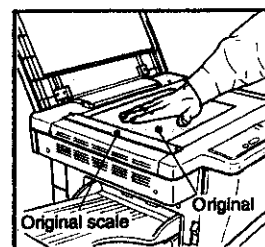

2 Make sure that the PHOTO  symbol is lit.

- If it is not, press the FUNCTION key to make its symbol come on.

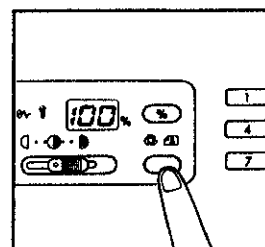

3 Select the desired copy size, reproduction ratio, copy quantity, etc. as required.

- If you want to select the desired copy density, move the manual exposure slide (see page 18).
- You cannot use the AUTOMATIC EXPOSURE  mode.

4 Press the PRINT  key.

5. SELECTING THE EXPOSURE MODE

There are two types of exposure, automatic exposure and manual exposure. In the automatic exposure mode, the machine will automatically detect the density of the original and select the optimum exposure. This mode is suitable for originals with letters and illustrations only. Originals with black areas and half-toned originals should be copied in manual exposure. In the manual exposure mode, you can make your copies lighter or darker.

Copying in Automatic Exposure

- 1 **Make sure that the AUTOMATIC EXPOSURE [☉] symbol is lit.**
 - If it is not, press the FUNCTION key to make its symbol come on.

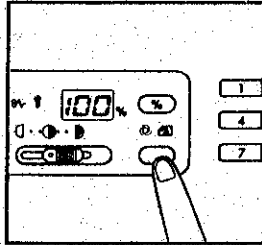

- 2 **Set the original and press the PRINT [☐] key.**
 - The machine will automatically detect the density of the original and make copies in the optimum exposure.

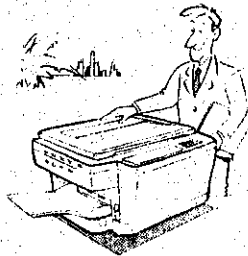

16

Copying in Manual Exposure

- 1 **Press the FUNCTION key to go into manual exposure.**
 - If the AUTOMATIC EXPOSURE [☉] symbol is lit, press the FUNCTION key to extinguish its symbol.
 - To lighten [◀] your copies, move the manual exposure slide toward the left.
 - To darken [▶] your copies, move the manual exposure slide toward the right.

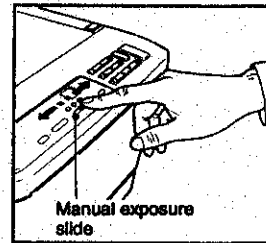
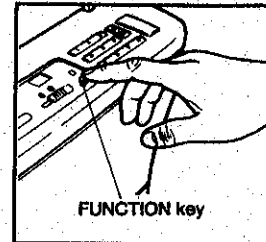



- 2 **Set the original and press the PRINT [☐] key.**
 - Copies will be made in the selected exposure.
 - Pressing the FUNCTION key will return the copier to automatic exposure.

17

6. INTERRUPT COPYING

If you want to interrupt a multicopy run and make a few copies of a different original, use the interrupt mode in the following manner.

- 1 Press the CLEAR/STOP  key to interrupt the multicopy run now proceeding.

- The lamp in the PRINT  key will change from red to green.

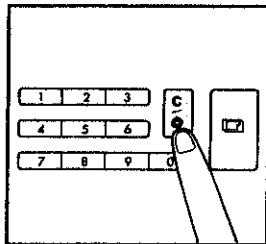

- 2 Replace the original with a new one.

- 3 Make copies using the procedure described in "BYPASS COPYING" on page 13.

- You can make any number of copies in the interrupt mode, but one by one. The copy quantity shown on the display will not change.

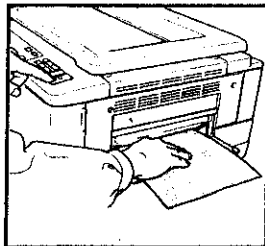

- 4 After having finished copying in the interrupt mode, replace the previous original.

- 5 Press the PRINT  key.
 - The interrupted multicopy run will be automatically resumed.



7. AUTO JOB START COPYING

During warm-up, if you set the desired copying mode and press the PRINT  key, the copier will automatically start copying when it becomes READY.

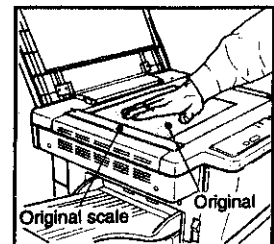
- 1 Place the original.
 - Set it face down on the glass.



- 2 Select the desired copy size reproduction ratio, copy quantity and exposure as required.

- 3 Press the PRINT  key.
 - The lamp in the PRINT  key will change from red to green flashes.
 - The copier will automatically start copying when it becomes READY.

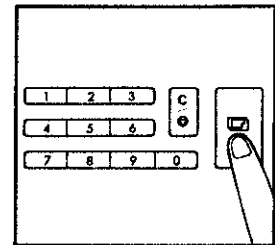

Note: To cancel the AUTO JOB START mode press the CLEAR/STOP  key.

Caution:

During auto job start copying, if you press the PRINT key continuously, the copier will enter the quick copying function (Option). So, in addition to the copy quantity entered in Step 2, the number of copies made will be increased according to the number of times that the PRINT key was pressed.

8. POWER SAVING MODE (Option)

If no copy is taken within the set time (*) after the end of warming up, the copier will automatically revert to the OFF situation. Only the PRINT key will be lit in red. You can make copies as described below.

(*) Set time (30 seconds through 30 minutes):
If you want to use this function, please ask your service technician to set for you.

1 Check that only the PRINT key is lighting in red.

- The other lamps should all be extinguished.

2 Press the PRINT key.

- The copier will enter the warming up condition and 30 seconds later the PRINT key lamp will light in green.
- It is particularly convenient to use the AUTO JOB START mode.

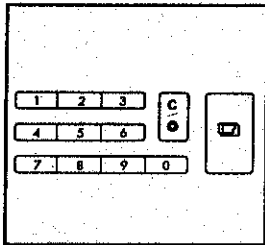

3 Place the original.

4 Select the desired exposure.

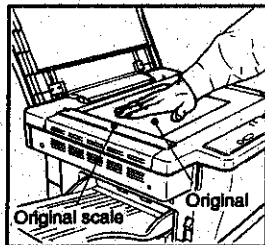

5 Press the PRINT key.

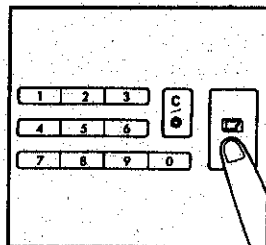

20

9. USING THE QUICK COPYING FUNCTION (Option)

Note: If you want to use this function, please ask your service technician to set it for you.

1 Place the original.

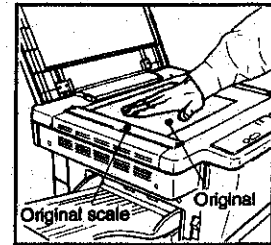

2 Select the desired exposure.

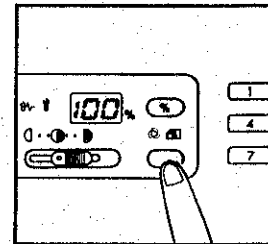

3 Press the PRINT key.

- Within 2 seconds after the start of copying, press the PRINT key as many times as the number of copies required.
- The number of copies made will correspond to the number of times that the PRINT key was pressed. This number will be shown on the copy quantity display.

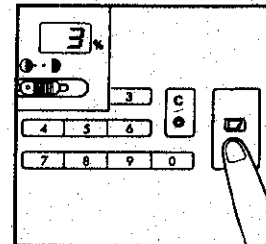

Caution:

During auto job start copying, do not press the PRINT key continuously, or the copier will enter the quick copying function mode.

21

WHEN THE GRAPHIC SYMBOLS FLASH

1. ADD PAPER SYMBOL

When the ADD PAPER  symbol flashes on the graphic display panel, this indicates that the paper supply in the paper cassette has been depleted. Add paper to the cassette using the following procedure.

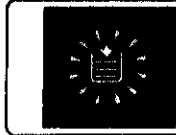

How to Remove or install the Paper Cassette:

- To remove the cassette: Holding it with both hands as shown, pull it out in a slightly upward direction.

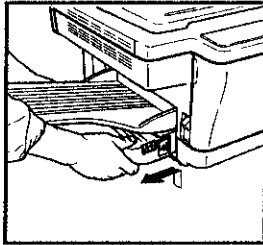

- To install the cassette: Holding it with both hands as shown, push it in until it comes to a stop.

Caution: Insert it properly up to the arrow label.

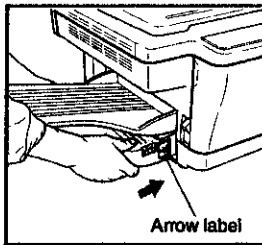

How to Place Paper in the Cassette:

- 1 Open the package and take out about half a ream (approx. 250 sheets) of paper.

- 2 Place the paper in the cassette with its edge touching the trailing edge guide.

- Open the package, take out the paper and place it with the package opening side facing down in the cassette.
- Do not place paper in the cassette above the marked line on the trailing-edge guide.

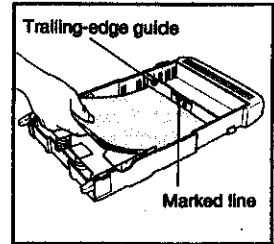

- 3 Push down the paper carefully with both hands to place it properly under the separation claws.

- When handling the paper, be careful not to damage it.
- Do not use creased, folded, wrinkled or damp sheets of paper.
- The paper remaining in the package should be kept, as it is, in a cool, dry area.

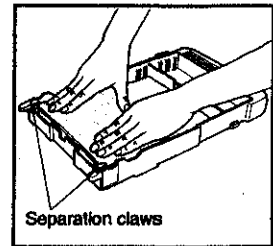

2. REPLACE TONER CARTRIDGE SYMBOL (1)

When the toner supply in the toner cartridge runs out, the REPLACE TONER CARTRIDGE  symbol flashes on the graphic display panel. Replace the toner cartridge using the following procedure.



Note: It is recommended that only toner cartridges made or designated by Toshiba be used for the 1340/1350 in order to optimize quality.

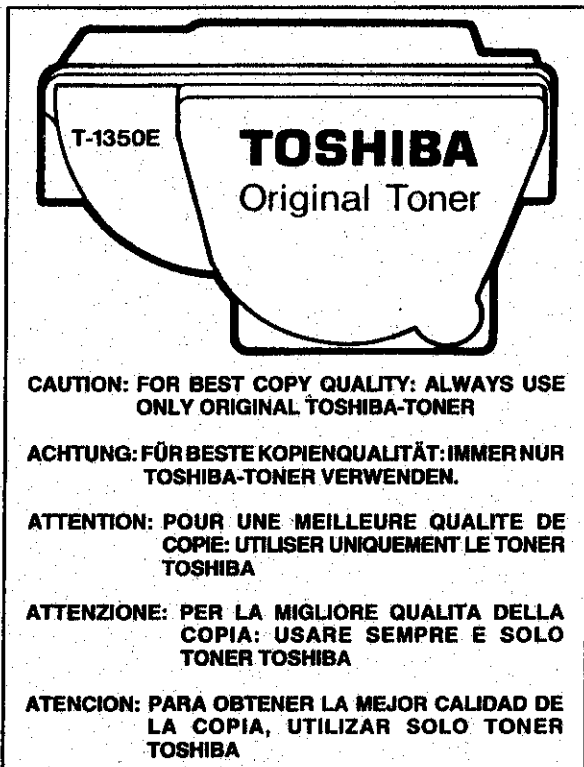

24

WHEN THE GRAPHIC SYMBOLS FLASH

How to Replace the Toner Cartridge

1 Open the front cover.

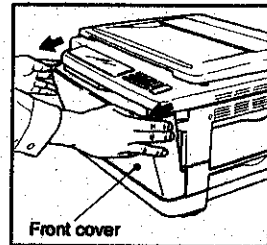

2 To remove the toner cartridge, push its locking lever and take it out toward you.

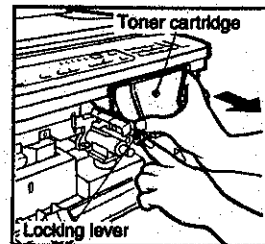

3 Shake the new toner cartridge to the right and to the left 5 or 6 times.

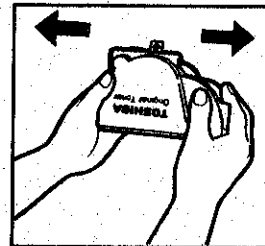

25

2. REPLACE TONER CARTRIDGE SYMBOL (2)

- 4 Before installing a new cartridge, pull off its seal in the direction of the arrow.

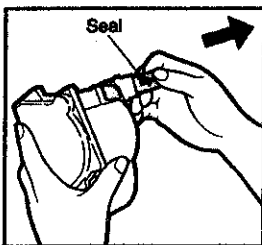

- 5 Install the new cartridge.
- Push in the cartridge until it comes to a stop and is firmly latched.
 - If any toner has spilled on the cover, wipe it clean.

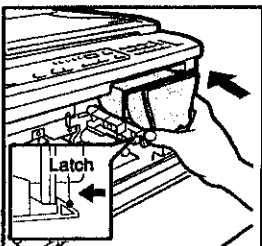

- 6 Close the front cover.

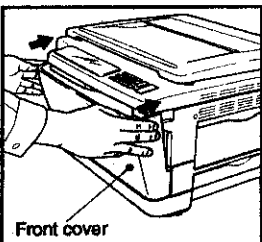

26

WHEN THE GRAPHIC SYMBOLS FLASH

3. REPLACE TONER BAG SYMBOL (1)

When the toner bag becomes full of used toner, the REPLACE TONER BAG  symbol will flash on the graphic display panel. Replace the toner bag using the following procedure.



How to Replace the Toner Bag

- 1 Open the front cover.

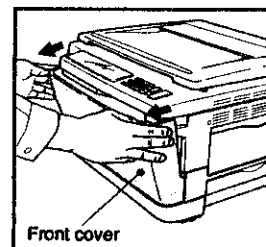

- 2 Pushing down on the upper unit with your left hand, pull the release lever to unlock the upper unit. Then, lift the upper unit slowly in the direction shown until it comes to a stop.

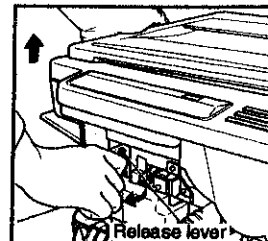

- 3 Take the used toner bag out from the machine.

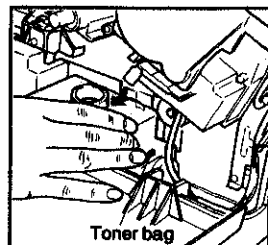

27

3. REPLACE TONER BAG SYMBOL (2)

- 4** Close the used toner bag with the cap.
- The cap is fitted on the side of the used toner bag.
 - The used toner bag should be disposed of properly.

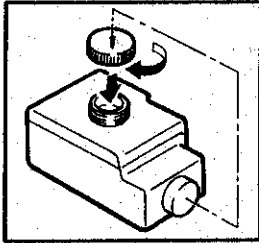

- 5** Set the new toner bag in the machine.

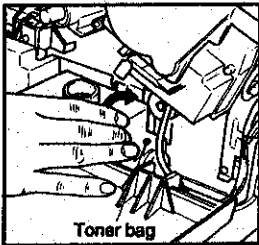

- 6** Push down the upper unit slowly until it latches firmly with a click.
- When closing the upper unit, be careful not to get your fingers caught between the upper and lower units.

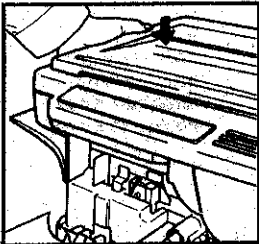

- 7** Close the front cover.

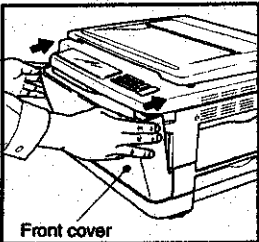

28

WHEN THE GRAPHIC SYMBOLS FLASH

4. CLEAR PAPER SYMBOL (1)

When a paper misfeed occurs in the copier, the CLEAR PAPER  symbol flashes on the graphic display panel. Remove the misfed paper using the following procedure.



- 1** Open the paper guide.
- 2** Remove the misfed paper if found.

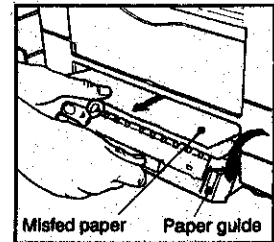

- 3** Close the paper guide.

- 4** Open the front cover.

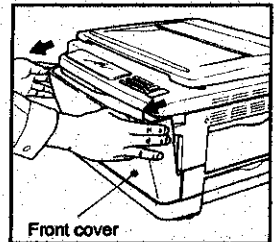

- 5** Pushing down on the upper unit with your left hand, pull the release lever to unlock the upper unit. Then, lift the upper unit slowly in the direction shown until it comes to a stop.

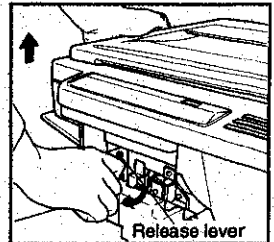

29

4. CLEAR PAPER SYMBOL (2)

6 Check the paper path for misfed paper, and remove if any is found.

(1) If paper is misfed in an area under the drum, remove the paper as shown.

- Turning the knob in the direction of the arrow, take out the paper.

Caution: Be careful not to touch the drum.

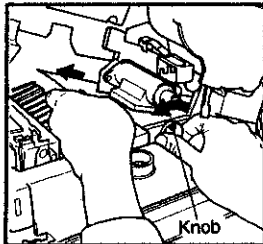

(2) If paper is misfed in the exit area of the fuser unit, lift up the fuser unit using the lever, remove the misfed paper, and then reset the fuser unit.

Caution: Be careful as the fuser unit may be HOT.

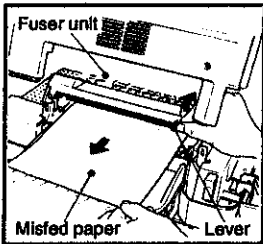

7 Close the upper unit firmly.

8 Close the front cover.

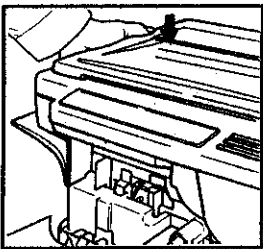

30





WHEN THE GRAPHIC SYMBOLS FLASH

5 CALL SERVICE SYMBOL

When the CALL SERVICE  Symbol flashes, this indicates that something abnormal has occurred in the copier. Turn off the power switch immediately and contact your service technician for assistance.



6 WHEN THE PRINT KEY LAMP DOES NOT BECOME GREEN

After the procedures described in the "ADD PAPER  Symbol", "REPLACE TONER CARTRIDGE  Symbol", "REPLACE TONER BAG  Symbol" and "CLEAR PAPER  Symbol" sections have been carried out, if the lamp on the PRINT  key does not change to green, turn off the power switch and call service for assistance.



31

MAINTENANCE

1. CLEANING THE CHARGERS

To maintain copy quality, chargers "A" and "B" should be cleaned periodically according to the following procedure. But before starting to clean, **BE SURE TO TURN OFF THE POWER SWITCH** and then open the front cover.

Cleaning Charger "A"

- 1 Holding charger "A" as shown, gently pull it out horizontally.

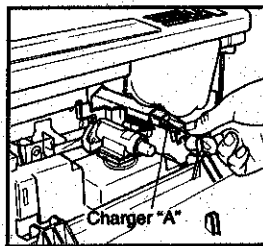

- 2 Holding the charger over a wastepaper basket, gently sweep the charger wire 2 or 3 times with the brush provided. Also brush the inside wall of the charger case.

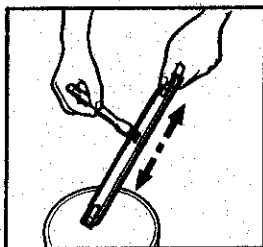

- Be sure not to press hard with the brush on the charger wire because it is very thin and delicate.
- If the charger wire is loose or broken, call your service technician.

- 3 To reinstall the charger, align the guide on the back of the charger with the rail on the machine and push the charger straight in until it comes to a stop.

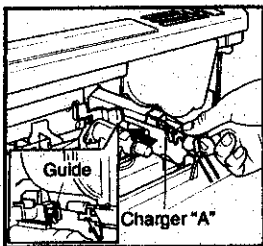

32

Cleaning Charger "B"

- 1 Pushing down on the upper unit with your left hand, pull the release lever to unlock the upper unit. Then, lift the upper unit slowly in the direction shown until it comes to a stop.

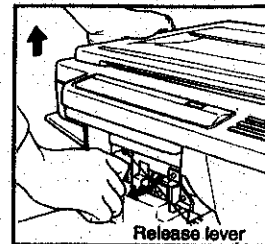

- 2 Gently sweep the charger wire 2 or 3 times with the brush provided.

- Be sure not to press hard with the brush on the charger wire because it is very thin and delicate.
- Be extremely careful not to damage the drum.

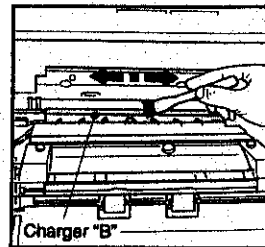

- 3 Push down the upper unit slowly until it is firmly latched.

- If the charger wire is loose or broken, call your service technician.

2. CLEANING THE COPIER

Cleaning the Glass and the Original Cover

Clean the glass of the copier with a suitable dry cloth and the original cover with alcohol when they become dirty. They should be cleaned preferably once a week.

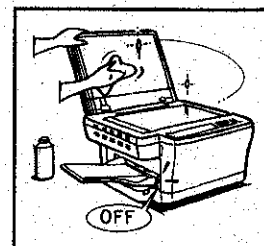

Cleaning the Outside Covers

When the outside covers of the copier become dirty, clean them using a cloth which should be soaked with a suitable neutral detergent and then squeezed tightly. After doing this, wipe off the detergent completely with a dry cloth.

33

3. SIMPLE TROUBLESHOOTING (1)

1. When the copier does not start:

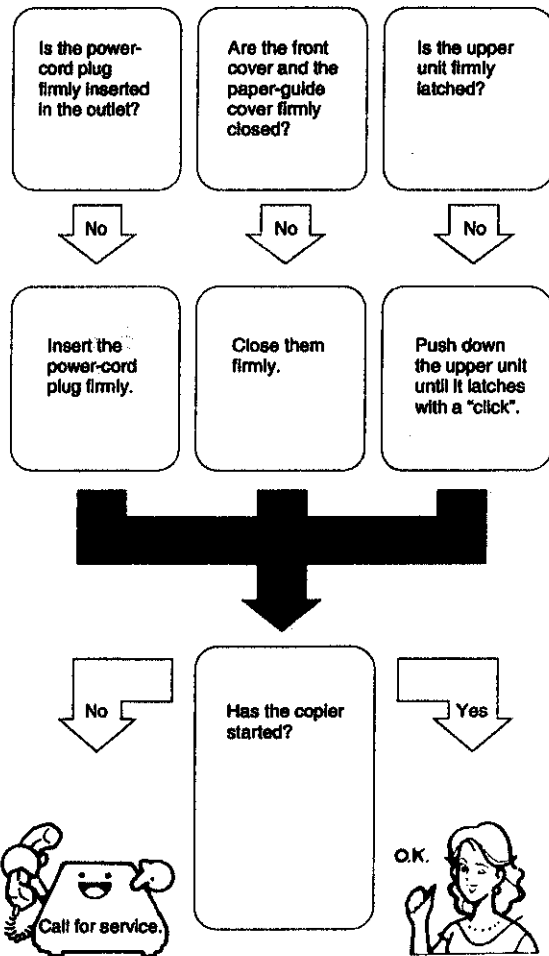

34

2. When no image is copied:

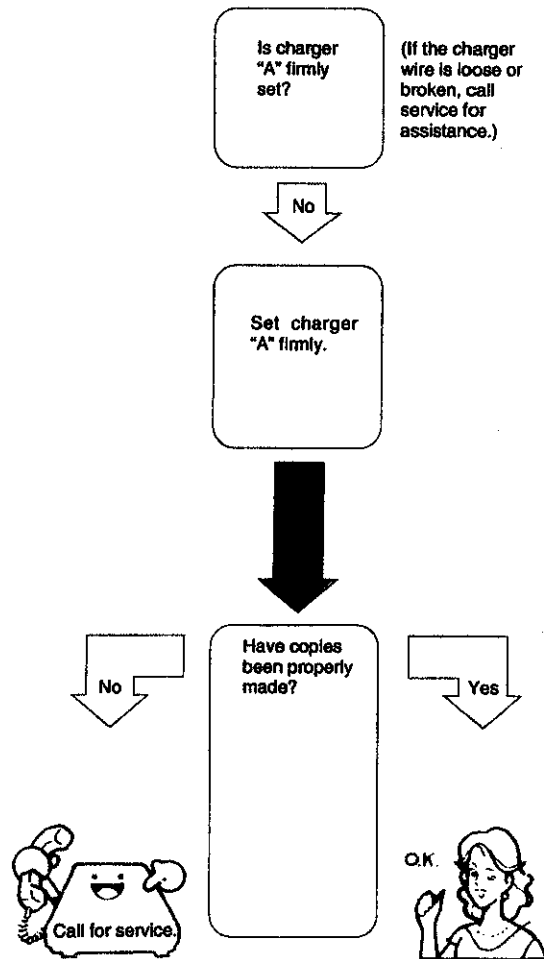

35

3. SIMPLE TROUBLESHOOTING (2)

3. When copies are dirty:

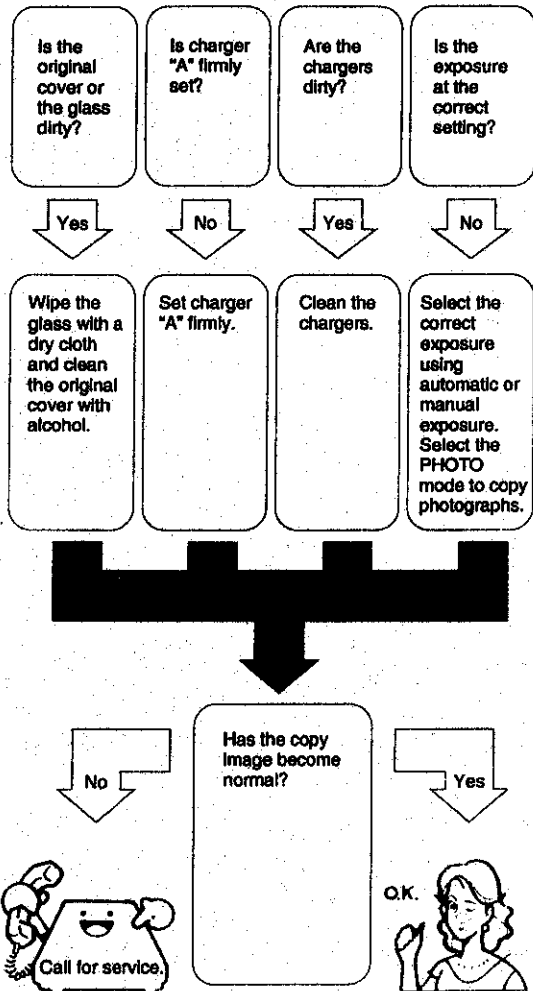

36

4. When copies are too light or too dark:

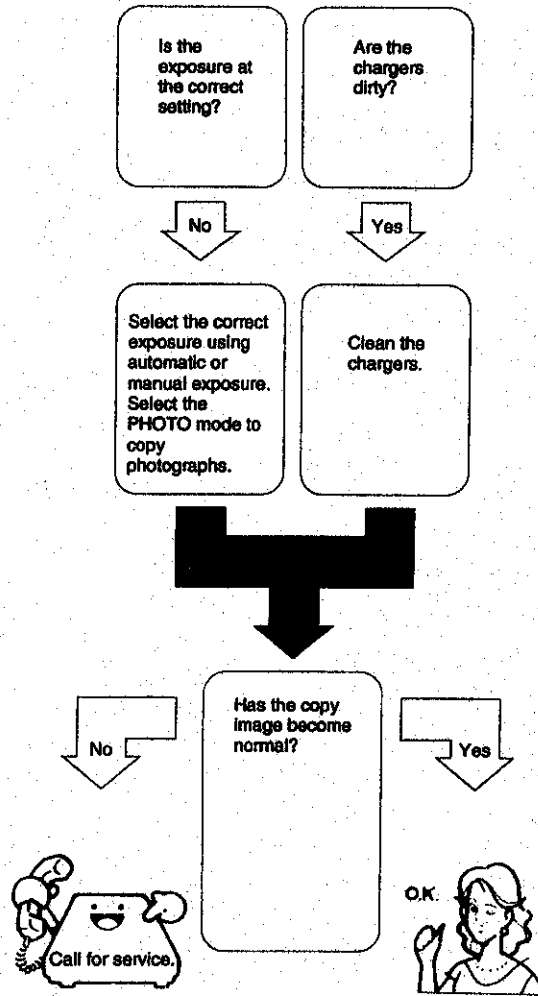

37

